



# Domino Ax-Series Spares Catalogue

**Ax150i**  
**Ax350i**  
**Ax550i**



# Contents

<b>Introduction</b> .....	<b>2</b>
<b>Consumable Kits, Tools &amp; Consumables</b> .....	<b>3</b>
Consumable Kits .....	3
Tools .....	5
Consumables .....	9
<b>1<sup>st</sup>, 2<sup>nd</sup> &amp; 3<sup>rd</sup> Level Spares</b> .....	<b>11</b>
1 <sup>st</sup> Level Spares .....	11
2 <sup>nd</sup> Level Spares .....	12
3 <sup>rd</sup> Level Spares .....	15
<b>i-Pulse Print Head Chassis</b> .....	<b>22</b>
<b>i-Pulse Print Head Assembly</b> .....	<b>31</b>
<b>i-Pulse RS Print Head Assembly</b> .....	<b>36</b>
<b>Duo Print Head Assembly</b> .....	<b>39</b>
<b>i-Techx System</b> .....	<b>43</b>
<b>Electronics Cabinet</b> .....	<b>55</b>
<b>AirDryer Spares</b> .....	<b>65</b>
<b>Documentation</b> .....	<b>67</b>
<b>Notes</b> .....	<b>69</b>

# Introduction

This document provides useful information about the current Ax-Series ancillaries and spares including photography, part numbers and descriptions.

**Note:** This is a working document and will be continuously updated. The newest version of this document will always be available from MyDomino.

# Consumable Kits, Tools & Consumables

## Consumable Kits





Image	Description	Quantity per kit
	<p><b>EPT025724</b> Starter Kit - Type 5</p> <p><b>Kit Components:</b> Wash Bottle 250ml Safety Glasses Low Lint Tissue Hycare (Sheet) Gloves, Disp Nitrile (Blue), Latex &amp; Powder, Large Wash Station Jug Hand Cleaner, Small 30ml Tube Print Head Cleaning Brush</p> <p><b>Note:</b> Low Lint Tissue and Wash Station Jug not available separately.</p>	<p>1 1 10 20 1 1 1</p>
	<p><b>EPT025349</b> Performance Kit - A-Series</p> <p><b>Kit Components:</b> Size L Blue Nitirle Powder Free Gloves Lint Free Wipes Safety Glasses Cleaning Bottle Hand Cleaner - Small 30ml 400ml Plastic Beaker T6 Torx Driver 6mm S/A Allen key 1.5mm Ball Allen Key 2mm Ball Allen Key Eye Glass</p> <p><b>Note:</b> Lint Free Wipes not available separately.</p>	<p>1 Pack 10 1 1 1 1 1 1 1 1</p>

Image	Description	Quantity per kit
	<p><b>ITM02</b> Ax-Series ITM Type 2 (Designed for Normal Ink System)</p> <p><b>ITM03</b> Ax-Series ITM Type 3 (Designed for Heavy Duty Ink System)</p> <p><b>ITM06</b> Ax-Series ITM Type 6 (Designed for Dye-Based Ink System)</p>	<p> </p> <p> </p> <p> </p>
	<p><b>26055</b> Cleaning Kit</p> <p><b>Kit Components:</b> Wash Bottle 250ml Hand Cleaner 250g Gloves, Natural Rubber Latex Disp, Powder Free, Large Paper 8" Dia x 10" M Tork</p>	<p> </p> <p> </p> <p> </p> <p> </p>

**Tools**

Image	Description	Quantity per kit
	<b>EPT034408</b> Short Jaw 8mm Spanner	1
	<b>EPT032546</b> Torx Driver Toolkit  <b>Kit Components:</b> Screwdriver T6 x 75mm Screwdriver T10 x 75mm Screwdriver T15 x 100mm Screwdriver T20 x 100mm Screwdriver T25 x 125mm Flexible Nut Spinner 7mm x 150mm  <b>Note:</b> Kit components not available separately.	1 1 1 1 1 1
	<b>EPT032301</b> T6 Torx Driver	1
	<b>30455</b> AirDryer Test Kit  <b>Kit Components:</b> Test Instructions Flow Meter and Chart Syringe 20ml Humidity Meter Tubing Silicone 7mm OD 3mmID  <b>Note:</b> Only Flow Meter and Chart available separately.	1 1 1 1 <b>0.6M</b>




Image	Description	Quantity per kit
	<p><b>30457</b> Flow Meter &amp; Chart</p>	<p>1</p>
	<p><b>26083</b> Beaker (Earthed)</p> <p><b>Kit Components:</b> Metal Beaker (550ml) Cable Assembly Nut M4 St St Washer M4 Shake proof St St Screw PAN Pozi St St M4x6</p> <p><b>Note:</b> Kit components not available separately.</p>	<p>1 1 1 2 1</p>
	<p><b>10700</b> Wrist Strap Coiled (1.5M Anti-Static)</p>	<p>1</p>
	<p><b>14484</b> Ball Driver (1.5mm)</p>	<p>1</p>







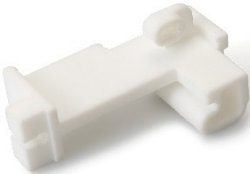
Image	Description	Quantity per kit
 A black, cylindrical eye glass with a flat top and a slightly wider base.	<b>I4547</b> Eye Glass	I
 A pair of clear, wrap-around safety glasses with a strap across the bridge.	<b>I4584</b> Safety Glasses	I
 A red, handheld tube cutter with a curved blade and a handle.	<b>I4549</b> Tube Cutters	I
 A white, plastic wash bottle with a white cap and a white nozzle.	<b>I4563</b> Wash Bottle (250ml)	I

Image	Description	Quantity per kit
	<b>EPT054062</b> Ax Deflector Plate Setting Gauge	1

**Consumables**

Image	Description	Quantity per kit
	<p><b>26046</b> Hand Cleaner (250g)</p>	<p>1</p>
	<p><b>99116</b> Paper 8" Dia x 10" M Tork</p>	<p>1</p>
	<p><b>Nitrile Gloves</b></p> <p>Small - <b>99289</b>                  Large (Large Box) - <b>99291</b>                  Large (Small Box) - <b>EPT038910</b>                  Extra Large - <b>99292</b></p> <p><b>Note:</b> Large box contains 100 gloves and small box contains 20 gloves.</p>	<p>1 1 1 1</p>

Image	Description	Quantity per kit
	<p><b>Latex Gloves, Powder Free</b></p> <p>Small - <b>99199</b>                  Medium - <b>99192</b>                  Large (Large Box) - <b>99119</b>                  Large (Small Box) - <b>EPT052312</b></p> <p><b>Note:</b> Large box contains 100 gloves and small box contains 20 gloves.</p>	<p>  </p>
	<p><b>Inks and Make-Up</b></p> <p><b>Note:</b> May vary depending on printer model, options and set up, please contact Domino.</p>	<p><b>N/A</b></p>

# 1<sup>st</sup>, 2<sup>nd</sup> & 3<sup>rd</sup> Level Spares

## 1<sup>st</sup> Level Spares

Image	Description	Quantity per kit
	<p><b>EPT015415SP</b> Filter Assembly Type 5 Spare</p>	<p>1</p>
	<p><b>ITM02</b> Ax-Series ITM Type 2 (Designed for Normal Ink System)</p> <p><b>ITM03</b> Ax-Series ITM Type 3 (Designed for Heavy Duty Ink System)</p> <p><b>ITM06</b> Ax-Series ITM Type 6 (Designed for Dye-Based Ink System)</p>	<p>1</p> <p>1</p> <p>1</p>
	<p><b>01210</b> Fuse 20x5 (T)1A (240V)</p>	<p>1</p>

## 2<sup>nd</sup> Level Spares




Image	Description	Quantity per kit
	<p><b>EPT013403SP</b> Module Latch (x2) Kit Type 5 Spare</p>	<p><b>2</b></p>
	<p><b>EPT021504SP</b> Low Drip Valve Type 5 Spare</p>	<p><b>1</b></p>
	<p><b>EPT021551SP</b> Ink System O-Ring Kit Type 5 Spare</p> <p><b>Kit Components:</b></p> <ul style="list-style-type: none"> <li>O-Ring 8.73 x 1.78 EPDM <b>20</b></li> <li>O-Ring 9.0 x 2.0 EPDM <b>20</b></li> <li>Reservoir O-Ring <b>10</b></li> <li>O-Ring 11.0 x 2.0 EPDM <b>10</b></li> <li>O-Ring 12.42 x 1.78 EPDM <b>20</b></li> <li>ORING 2.9X1.78 EPDM <b>10</b></li> <li>ORING 4_48X1_78 EPDM <b>40</b></li> <li>ORING 5.28X1.78 EPDM <b>10</b></li> <li>ORING 6.5X1.5 EPDM <b>10</b></li> </ul> <p><b>Note:</b> Ink System O-Ring Kit components not available separately.</p>	<p><b>20</b></p> <p><b>20</b></p> <p><b>10</b></p> <p><b>10</b></p> <p><b>20</b></p> <p><b>10</b></p> <p><b>40</b></p> <p><b>10</b></p> <p><b>10</b></p>

Image	Description	Quantity per kit
	<p><b>EPT021552SP</b> Ink System Fasteners Kit Type 5 Spare</p> <p><b>Kit Components:</b> Screw 3 x 24.5 WNI56-2 T10 A2 Remform Screw K40 x 14 WNI45I Screw 3 x 10 WNI56-2 T10 A2 Remform Screw 3 x 8 WNI56-1 T10 A2 Remform Screw 3 x 18 WNI56-2 T10 A2 Remform</p> <p><b>Note:</b> Ink System Fastener Kit components not available separately.</p>	<p><b>100</b></p> <p><b>60</b></p> <p><b>200</b></p> <p><b>100</b></p> <p><b>50</b></p>
	<p><b>EPT022060SP</b> Cabinet Fasteners Kit Type 5 Spare</p> <p><b>Kit Components:</b> Screw M3 x 10 BUT FLG Torx T10 SS K30 PLAS-TECH Screw M4 x 10 HEX HD SS Captive Washer Washer M4 Shake Proof St St Screw M5 x 8 CSK HD Torx T25 SS Screw M5 x 30 CAP HD Torx T25 SS Screw M4 x 20 HEX HD SS Captive Washer Screw M3 x 8 CSK HD Torx T10 SS Screw M3 x 8 BUT HD Torx T10 SS IP65 Nylon Washer Screw M3 x 8 BUT HD Torx T10 SS Captive Washer Screw M4 x 45 BUT HD Torx T20 SS Captive Washer Screw M3 x 5 BUT HD Torx T10 SS Captive Washer</p> <p><b>Note:</b> Cabinet Fastener Kit components not available separately.</p>	<p><b>60</b></p> <p><b>40</b></p> <p><b>20</b></p> <p><b>30</b></p> <p><b>30</b></p> <p><b>40</b></p> <p><b>20</b></p> <p><b>40</b></p> <p><b>100</b></p> <p><b>20</b></p> <p><b>40</b></p>

Image	Description	Quantity per kit
	<p><b>EPT021664SP</b> Print Head Fasteners Kit Type 5 Spare</p> <p><b>Kit Components:</b></p> <p>Screw M2.2 x 8 PAN HD Torx T6 SS K22 PLAS-TECH <b>80</b></p> <p>Screw M2 x 4 CAP HD Torx T6 SS <b>20</b></p> <p>Screw M2 x 6 CAP HD Torx T6 SS <b>20</b></p> <p>Screw M2 x 6 CAP HD Torx T6 SS Captive Washer <b>100</b></p> <p>Screw M3 x 5 BUT HD Torx T10 SS <b>10</b></p> <p>Screw M4 x 6 BUT HD Torx T20 SS <b>10</b></p> <p>Screw M3 x 6 CSK HD Torx T10 SS <b>20</b></p> <p>Screw CSK Pozi, M2 x 5 St St <b>10</b></p> <p>Nut Lock M3 <b>10</b></p> <p>Screw M2 x 8 CAP HD Torx T6 SS <b>10</b></p> <p>Screw M3 x 10 BUT FLG Torx T10 SS K30 PLAS-TECH <b>20</b></p> <p>Screw M3 x 16 BUT FLG Torx T10 SS K30 PLAS-TECH <b>10</b></p> <p>Screw M2 x 12 CAP HD Torx T6 SS <b>10</b></p> <p><b>Note:</b> Print Head Fastener kit components not available separately.</p>	



**3<sup>rd</sup> Level Spares**

Image	Description	Quantity per kit
	<p><b>Nozzle Kit Type 5 Spare</b></p> <p><b>EPT036539SP</b> - 40 Micron  <b>EPT036546SP</b> - 50 Micron  <b>2-0160125SP</b> - 60 Micron  <b>2-0160124SP</b> - 75 Micron</p> <p><b>Kit Components:</b>                  Positive Tag                  Piezo Ceramic Disc                  Insulating Sleeve                  O-Ring EPDM 3.3 ID x 0.95 CS                  60/ 75 Micron Nozzle Assembly                  Wire 7/0.2 Pink                  Crimp Minitex 22-24 AWG</p> <p><b>Note:</b> Kit components not available separately.</p>	<p>1 1 1 1  1 2 1 1 1 1 1</p>
	<p><b>2-0110165SP</b>                  Piezo Ceramic Disc (x2) Kit Type 5 Spare</p>	<p>1</p>
	<p><b>2-0110158SP</b>                  Nozzle O-Ring Kit (x10) Type 5 Spare</p> <p><b>Kit Components:</b>                  O-Ring EPDM 3.3 ID x 0.95 CS</p>	<p>1  10</p>
	<p><b>Heater, Thermistor and Solenoid Assembly Type 5 Spare</b></p> <p>50, 60, 75 µm - <b>EPT006277SP</b>                  40 µm - <b>EPT034640SP</b></p>	<p>1 1</p>





Image	Description	Quantity per kit
	<p><b>EPT006886SP</b> High Voltage PSU Type 5 Spare</p>	<p>1</p>
	<p><b>EPT033207SP</b> LVPS 2 Ultrawide &amp; 6A Power Connector Kit Spare</p>	<p>1</p>
	<p><b>EPT026355SP</b> Power Connector Type 6 Spare</p>	<p>1</p>
	<p><b>EPT007517SP</b> Gutter Pump Type 5 Spare</p>	<p>1</p>
	<p><b>EPT009810SP</b> Make-Up Module Type 5 Spare</p>	<p>1</p>

Image	Description	Quantity per kit
	<p><b>EPT023718SP</b> Solenoid Assembly Ink Block Type 5 Spare</p>	<p>1</p>
	<p><b>EPT013308SP</b> Product Detect / Shaft Encoder PCB Kit Type 5 Spare</p> <p><b>Kit Components:</b> Product Detect / Shaft Encoder PCBA - Dual Cap, Protection, Female Socket Cable, Product Detect / Shaft Encoder</p> <p><b>Note:</b> Kit components not available separately.</p>	<p>1 2 1</p>
	<p><b>EPT013507SP</b> Viscometer Assembly Kit Type 5 Spare</p> <p><b>Kit Components:</b> Viscometer Assembly Basic General Build (Bayonet) LLDPE Tubing 6mm Natural</p> <p><b>Note:</b> Tubing available separately.</p>	<p>1 0.4M</p>
	<p><b>Strobe &amp; Charge Electrode Assembly Type 5 Spare</b></p> <p>40 &amp; 50 <math>\mu\text{m}</math> - <b>EPT032311SP</b> 60, 75 <math>\mu\text{m}</math> &amp; H90 - <b>EPT015169SP</b> V90 - <b>EPT033576SP</b></p>	<p>1 1 1</p>

Image	Description	Quantity per kit
	<p><b>EPT016969SP</b> Pressure Sensor Type 5 Spare</p>	<p>1</p>
	<p><b>EPT016967SP</b> Vacuum Sensor Type 5 Spare</p>	<p>1</p>
	<p><b>EPT017291SP</b> Fan Assembly Type 5 Spare</p>	<p>1</p>
	<p><b>Deflector Plate Assembly Type 5 Spare</b> 40 µm - <b>EPT026585SP</b> 50 µm - <b>EPT026590SP</b> 60, 75 µm &amp; H90 - <b>EPT017396SP</b> V90 - <b>EPT033546SP</b></p>	<p>1 1 1 1</p>





Image	Description	Quantity per kit
	<b>EPT017909SP</b> Main Control PCB Type 5 Spare	1
	<b>EPT018862SP</b> Feed Filter Assembly Type 5 Spare	1
	<b>EPT018872SP</b> Damper Assembly Type 5 Spare	1
	<b>EPT019977SP</b> Programmed 8GB Flash Card Type 5 Spare	1







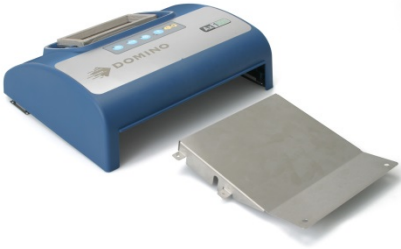
Image	Description	Quantity per kit
	<p><b>EPT019979SP</b> 32KB Smart Card Type 5 Spare</p>	<p>1</p>
	<p><b>EPT021516SP</b> Jet Pump Kit Type 5 Spare</p> <p><b>Kit Components:</b> Jet Pump Nozzle Vertical Shield O-Ring 12.45 x 1.78 EPDM O-Ring 6.5 x 1.5 EPDM</p> <p><b>Note:</b> Kit components not available separately.</p>	<p>1</p>
	<p><b>EPT021639SP</b> Print Head Cover Kit Type 5 Spare</p> <p><b>Kit Components:</b> Holster Retaining Clips Wire Box Lid Seal Wirebox Cover Wirebox Dovetail Wirebox</p> <p><b>Note:</b> Kit components not available separately.</p>	<p>2 1 1 1 1 1</p>
	<p><b>EPT023712SP</b> Gear Pump Assembly Type 5 Spare</p> <p><b>Kit Components:</b> Gear Pump LLDPE Tubing 6mm Natural LLDPE Tubing 8mm Natural</p> <p><b>Note:</b> Tubing available separately.</p>	<p>1 <b>0.435M</b> <b>0.415M</b></p>

Image	Description	Quantity per kit
	<p><b>EPT027778SP</b> Cable, Stroboscope, 3M</p> <p><b>Note:</b> For use with Stroboscope and Cable - EPT027809, in Ax-Series Accessories Catalogue.</p>	<p>1</p>
	<p><b>EPT028743SP</b> Front Door UI Parts Kit (Ax150i) Spare</p> <p><b>Kit Components:</b> Screw M3 x 10 BUT FLG Torx T10 SS K30 PLAS-TECH PCBA 7" UI HEX Stand Off Cable, UI Cable, Keypad 7" UI Front Assembly</p> <p><b>Note:</b> Kit components not available separately.</p>	<p>12 1 2 1 1 1</p>
	<p><b>EPT029088SP</b> Front Door Assembly (No UI) Parts Kit (Ax150i) Spare</p>	<p>1</p>

# i-Pulse Print Head Chassis




Image	Description	Quantity per kit
	<p><b>Print Head &amp; Conduit Assembly Type 5 Spare</b></p> <p>3M 40 µm - <b>EPT032898SP</b>            4M 40 µm - <b>EPT032899SP</b>            3M 50 µm - <b>EPT032930SP</b>            4M 50 µm - <b>EPT032931SP</b>            3M 60 µm - <b>EPT027442SP</b>            6M 60 µm - <b>EPT027785SP</b>            3M 75 µm - <b>EPT027786SP</b>            6M 75 µm - <b>EPT027787SP</b></p>	<p>I I I I I I I I</p>
	<p><b>Print Head &amp; Conduit Assembly H90 Type 5 Spare</b></p> <p>3M 60 µm - <b>EPT027984SP</b>            6M 60 µm - <b>EPT027986SP</b>            3M 75 µm - <b>EPT027985SP</b>            6M 75 µm - <b>EPT027987SP</b></p>	<p>I I I I</p>
	<p><b>Print Head &amp; Conduit Assembly V90 Type 5 Spare</b></p> <p>3M 60 µm - <b>EPT034167SP</b>            6M 60 µm - <b>EPT034165SP</b>            3M 75 µm - <b>EPT034168SP</b>            6M 75 µm - <b>EPT034166SP</b></p>	<p>I I I I</p>




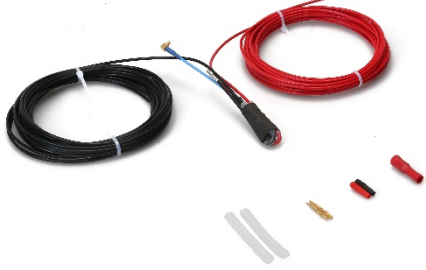
Image	Description	Quantity per kit
	<p><b>Conduit Assembly</b></p> <p>3M 40 &amp; 50 µm - <b>EPT018086SP</b></p> <p>3M 60 &amp; 75 µm - <b>EPT015181SP</b></p> <p>4M 40 &amp; 50 µm - <b>EPT018097SP</b></p> <p>4M 60 &amp; 75 µm - <b>EPT018097SP</b></p> <p>6M 60 &amp; 75 µm - <b>EPT017598SP</b></p> <p><b>Note:</b> Conduit type dependant on ink type and print head combination.</p>	<p> </p> <p> </p> <p> </p> <p> </p> <p> </p>
	<p><b>EPT058523</b> Ax EHT Replacement Kit Type 5 Spare</p> <p><b>Kit Components:</b></p> <p>Wire 19/0.2 9KV PTFE Black</p> <p>Wire 19/0.2 9KV PTFE Red</p> <p>Sleeving Heat Shrink 3.2 Clear</p> <p>Sleeving Heat Shrink 4.80 Clear</p> <p>Insulated Female Bullet Terminal</p> <p>Plug 2mm 10AMP Black</p> <p>Plug 2mm 10AMP Red</p> <p>Sleeving Heat Shrink 3/8 Inch Black</p>	<p> </p> <p> </p> <p><b>0.10m</b></p> <p><b>0.10m</b></p> <p> </p> <p> </p> <p> </p> <p><b>0.05m</b></p>

Image	Description	Quantity per kit
	<p><b>Print Head Chassis Type 5 Spare</b></p> <p>40 µm - <b>EPT026812SP</b>                      50 µm - <b>EPT027065SP</b>                      60, 75 µm - <b>EPT015205SP</b></p> <p><b>H90 - EPT022499SP</b></p> <p><b>V90 - EPT022294SP</b></p>	<p><b>1</b></p> <p><b>1</b></p> <p><b>1</b></p> <p><b>1</b></p> <p><b>1</b></p>
	<p><b>Holster Assembly Type 5 Spare</b></p> <p>40 µm - <b>EPT032848SP</b>                      50 µm - <b>EPT032929SP</b>                      60, 75 µm - <b>EPT019488SP</b></p> <p><b>H90 - EPT022521SP</b></p> <p><b>V90 - EPT022296SP</b></p>	<p><b>1</b></p> <p><b>1</b></p> <p><b>1</b></p> <p><b>1</b></p> <p><b>1</b></p>

Image	Description	Quantity per kit
	<p><b>EPT024562SP</b> Lens Assembly (Pack of 5) Type 5 Spare</p>	<p>1</p>
	<p><b>26798</b> Mounting Plate</p>	<p>1</p>
	<p><b>EPP001943SP</b> Conduit Sheath 6m (i-Tech/Ax) Spare</p>	<p>1</p>
	<p><b>EPT021639SP</b> Print Head Cover Kit Type 5 Spare</p> <p><b>Kit Components:</b> Holster Retaining Clips Wire Box Lid Seal Wirebox Cover Wirebox Dovetail Wirebox</p> <p><b>Note:</b> Kit components not available separately.</p>	<p>2 1 1 1 1 1</p>

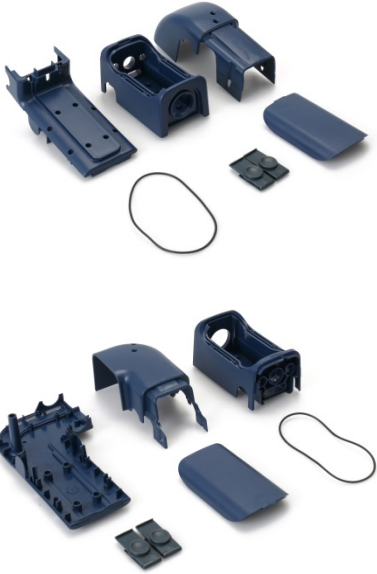
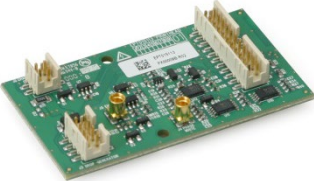
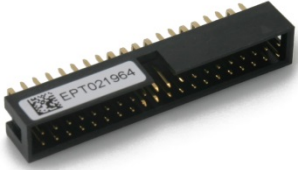
Image	Description	Quantity per kit
	<p><b>i-Pulse Maintenance Kit Type 5 Spare</b></p> <p>V90 - <b>EPT045623</b></p> <p>H90 - <b>EPT045624</b></p>	<p>I</p> <p>I</p>
	<p><b>EPT033017SP</b> Print Head PCBA 40/50/60/75 µm Type 5 Spare</p>	<p>I</p>
	<p><b>Jumper Link Connector Type 5 Spare</b></p> <p>3M 40 µm - <b>EPT021966SP</b></p> <p>4M 40 µm - <b>EPT021967SP</b></p> <p>3M 50 µm - <b>EPT036400SP</b></p> <p>4M 50 µm - <b>EPT036401SP</b></p> <p>3M 60 µm - <b>EPT021964SP</b></p> <p>6M 60 µm - <b>EPT021965SP</b></p> <p>3M 75 µm - <b>EPT021970SP</b></p> <p>6M 75 µm - <b>EPT021971SP</b></p>	<p>I</p> <p>I</p> <p>I</p> <p>I</p> <p>I</p> <p>I</p> <p>I</p> <p>I</p>

Image	Description & Location	Quantity per kit
	<p><b>98121</b> Sleeving Heat shrink 3mm BK S/A</p>	<p><b>Sold by Metre</b></p>
	<p><b>98201</b> Tube PTFE 1/8 Nat to Spec</p>	<p><b>Sold by Metre</b></p>
	<p><b>01042</b> Skt Brass Turned 1.02mm PIN</p>	<p><b>1</b></p>
	<p><b>01043</b> Plug PIN 1.02mm PIN Brass Gold</p>	<p><b>1</b></p>



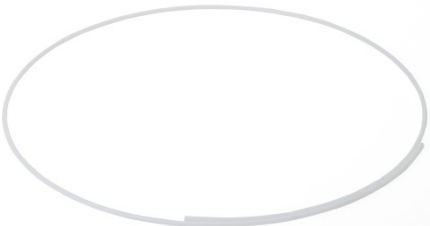

Image	Description	Quantity per kit
	<p><b>98094</b> Sleeving Heat Shrink 4.80 Clear</p>	<p><b>Sold by Metre</b></p>
	<p><b>98108</b> Sleeve Heat Shrink 3.2mm Black</p>	<p><b>Sold by Metre</b></p>
	<p><b>2-0140061SP</b> Tube PTFE 2 ID x 0.5 Wall</p>	<p><b>Sold by 10 Metre</b></p>
	<p><b>EPT034279SP</b> Tube Kit Type 5 Spare</p> <p><b>Kit Components:</b> LLDPE Tubing 6mm Natural Tube 8mm x 415mm - LLDPE</p> <p><b>Note:</b> Kit components not available separately.</p>	<p><b>2M 0.415M</b></p>





Image	Description	Quantity per kit
	<p><b>EPT018338SP</b>                      Tube PTFE 3.2mm O/D 1.48mm I/D - Black Stripe 5.05M Spare</p>	<p><b>Sold by Metre</b></p>
	<p><b>EPT026060SP</b>                      Tube PTFE 3.175 O/D 2.0mm I/D Internal Stripe Violet 7.05M Spare</p>	<p><b>Sold by Metre</b></p>
	<p><b>EPT033199SP</b>                      Tube PTFE 3.175 O/D 2.2mm I/D Internal Stripe Orange 7.275M Spare</p>	<p><b>Sold by Metre</b></p>

Image	Description	Quantity per kit
	<p><b>EPT021664SP</b> Print Head Fasteners Kit Type 5 Spare</p> <p><b>Kit Components:</b></p> <p>Screw M2.2 x 8 PAN HD Torx T6 SS K22 PLAS-TECH</p> <p>Screw M2 x 4 CAP HD Torx T6 SS</p> <p>Screw M2 x 6 CAP HD Torx T6 SS</p> <p>Screw M2 x 6 CAP HD Torx T6 SS Captive Washer</p> <p>Screw M3 x 5 BUT HD Torx T10 SS</p> <p>Screw M4 x 6 BUT HD Torx T20 SS</p> <p>Screw M3 x 6 CSK HD Torx T10 SS</p> <p>Screw CSK Pozi, M2 x 5 St St</p> <p>Nut Lock M3</p> <p>Screw M2 x 8 CAP HD Torx T6 SS</p> <p>Screw M3 x 10 BUT FLG Torx T10 SS K30 PLAS-TECH</p> <p>Screw M3 x 16 BUT FLG Torx T10 SS K30 PLAS-TECH</p> <p>Screw M2 x 12 CAP HD Torx T6 SS</p> <p><b>Note:</b> Print Head Fastener kit components not available separately.</p>	<p><b>80</b></p> <p><b>20</b></p> <p><b>20</b></p> <p><b>100</b></p> <p><b>10</b></p> <p><b>10</b></p> <p><b>20</b></p> <p><b>10</b></p> <p><b>10</b></p> <p><b>10</b></p> <p><b>20</b></p> <p><b>10</b></p> <p><b>10</b></p>



# i-Pulse Print Head Assembly

Image	Description	Quantity per kit
	<p><b>Drop Generator Assembly</b></p> <p>40 µm - <b>EPT016224SP</b>            50 µm - <b>EPT016225SP</b>            60 µm - <b>EPT015160SP</b>            75 µm - <b>EPT016226SP</b>            V90 60 µm - <b>EPT033577SP</b>            V90 75 µm - <b>EPT033578SP</b></p>	<p>1 1 1 1 1 1</p>
	<p><b>Drop Generator Adapter Type 5 Spare</b></p> <p>60 µm - <b>EPT009430SP</b>            75 µm - <b>EPT018385SP</b></p>	<p>1 1</p>
	<p><b>Nozzle Kit Type 5 Spare</b></p> <p><b>EPT036539SP</b> - 40 Micron  <b>EPT036546SP</b> - 50 Micron  <b>2-0160125SP</b> - 60 Micron  <b>2-0160124SP</b> - 75 Micron</p> <p><b>Kit Components:</b></p> <p>Positive Tag            Piezo Ceramic Disc            Insulating Sleeve            O-Ring EPDM 3.3 ID x 0.95 CS            60/ 75 Micron Nozzle Assembly            Wire 7/0.2 Pink            Crimp Minitex 22-24 AWG</p> <p><b>Note:</b> Kit components not available separately.</p>	<p>1 1 1 1 2 1 1 1</p>
	<p><b>2-0110165SP</b>            Piezo Ceramic Disc (x2) Kit Type 5 Spare</p>	<p>1</p>


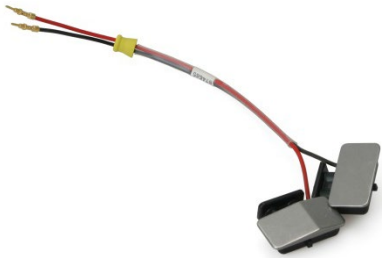


	<p><b>2-0110158SP</b> Nozzle O-Ring Kit (x10) Type 5 Spare</p> <p><b>Kit Components:</b> O-Ring EPDM 3.3 ID x 0.95 CS</p>	<p>I</p> <p>10</p>
	<p><b>Deflector Plate Assembly Type 5 Spare</b></p> <p>40 µm - <b>EPT026585SP</b> 50 µm - <b>EPT026590SP</b> 60, 75 µm &amp; H90 - <b>EPT017396SP</b> V90 - <b>EPT033546SP</b></p>	<p>I</p> <p>I</p> <p>I</p> <p>I</p>
	<p><b>Deflector Plate Assembly Type 5 Spare</b></p> <p>40 µm - <b>EPT026585SP</b> 50 µm - <b>EPT026590SP</b> 60, 75 µm &amp; H90 - <b>EPT017396SP</b> V90 - <b>EPT033546SP</b></p>	<p>I</p> <p>I</p> <p>I</p> <p>I</p>
	<p><b>Strobe &amp; Charge Electrode Assembly Type 5 Spare</b></p> <p>40 &amp; 50 µm - <b>EPT032311SP</b> 60, 75 µm &amp; H90 - <b>EPT015169SP</b> V90 - <b>EPT033576SP</b></p>	<p>I</p> <p>I</p> <p>I</p>

Image	Description	Quantity per kit
	<p><b>EPT042129SP</b> Print Head Adjustment Kit Type 5 Spare</p> <p><b>Kit Components:</b> Grommet 9.5mm Screw M2x6 Cap HD Torx T6 SS Captive Washer Adjusting Screw Adjusting Shaft Locking Screw Cam Grommet Retaining Screw</p> <p><b>Note:</b> Kit components not available separately.</p>	<p>2 2 1 1 1 1 2</p>
	<p><b>EAS003008SP</b> SureStart Earth Clip</p> <p><b>Note:</b> Mounted on rear of chassis.</p>	<p>1</p>
	<p><b>EPT015207SP</b> Drop Generator Mount Type 5 Spare</p>	<p>1</p>
	<p><b>26871</b> Retainer</p>	<p>1</p>






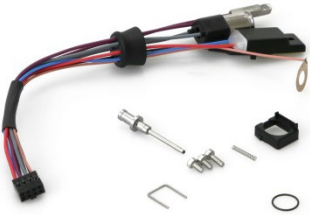

Image	Description	Quantity per kit
	<p><b>36726</b> Pivot Drop Generator Mount</p>	<p>1</p>
	<p><b>EPT031454SP</b> Gutter Tube Clamp Type 5 Kit</p> <p><b>Kit Components:</b> Gutter Tube Gutter Tube Clamp Block</p> <p><b>Note:</b> Kit components not available separately.</p>	<p>1 1</p>
	<p><b>36706</b> Tube Connector Gutter</p>	<p>1</p>
	<p><b>36820</b> Gutter Tube Adapter</p>	<p>1</p>

Image	Description	Quantity per kit
	<p><b>EPT063329SP</b> Gutter Tube Kit Type 5 Spare</p> <p><b>Kit Components:</b> Tube Connector Gutter Gutter Tube Adapter Sensor Tube Std</p>	<p>1 1 1</p>
	<p><b>Heater, Thermistor and Solenoid Assembly Type 5 Spare</b></p> <p>50, 60, 75 <math>\mu\text{m}</math> - <b>EPT006277SP</b> 40 <math>\mu\text{m}</math> - <b>EPT034640SP</b></p>	<p>1 1</p>
	<p><b>EPT029260SP</b> i-Pulse Flush Adapter Kit Spare</p>	<p>1</p>

# i-Pulse RS Print Head Assembly

Image	Description	Quantity per kit
	<p><b>Print Head &amp; Extruded Conduit Assembly RS Type 5 Spare</b></p> <p>3M 40 µm - <b>EPT033344SP</b>                      3M 50 µm - <b>EPT033346SP</b>                      4M 50 µm - <b>EPT033347SP</b>                      3M 60 µm - <b>EPT033342SP</b>                      6M 60 µm - <b>EPT033343SP</b>                      3M 75 µm - <b>EPT033348SP</b>                      6M 75 µm - <b>EPT033349SP</b></p>	<p>I I I I I I I</p>
	<p><b>Extruded Conduit Assembly Type 5 Spare</b></p> <p>3M 60/75 µm - <b>EPT031739SP</b>                      6M 60/75 µm - <b>EPT032414SP</b>                      3M 40/50 µm - <b>EPT032427SP</b>                      4M 40/50 µm - <b>EPT032447SP</b></p>	<p>I I I I</p>
	<p><b>Holster Assembly RS Type 5 Spare</b></p> <p>40/75 µm - <b>EPT030206SP</b>                      50/60 µm - <b>EPT030092SP</b></p> <p><b>Note:</b> No lens included with i-Pulse RS Print Head.</p>	<p>I I</p>
	<p><b>EPT030027SP</b>                      Print Head PCBA RS Type 5 Spare</p>	<p>I</p>

Image	Description	Quantity per kit
	<p><b>EPT030147SP</b> Drop Generator Cover Kit RS Type 5 Spare</p>	<p>1</p>
	<p><b>Print Head Chassis With H.V. Plates, C.E. &amp; Gutter Assembly RS Type 5 Spare</b></p> <p>40 µm - <b>EPT030216SP</b> 50/60 µm - <b>EPT030099SP</b> 75 µm - <b>EPT030287SP</b></p>	<p>1 1 1</p>
	<p><b>EPT036597SP</b> Print Head O-Ring Kit RS Type 5 Spare</p> <p><b>Kit Components:</b> O-Ring EPDM 34.65 ID 1.78 CS O-Ring 2.7 x 1.5 O-Ring 4.0 x 1.5 O-Ring 1.5 x 0.5</p> <p><b>Note:</b> Print Head O-Ring Kit RS components not available separately.</p>	<p>3 9 3 3</p>
	<p><b>EPT037089SP</b> Fasteners Kit RS Type 5 Spare</p>	<p>1</p>

Image	Description	Quantity per kit
	<p><b>EPT037091SP</b> Print Head Adjustment Kit RS Type 5 Spare</p>	<p>1</p>
	<p><b>EPT037095SP</b> Gutter Kit RS Type 5 Spare</p>	<p>1</p>
	<p><b>EPT026884SP</b> RS Flush Adapter Kit Spare</p>	<p>1</p>
	<p><b>EPT061435SP</b> RS Print Head Jet Adjustment Shim Kit Spare</p> <p><b>Kit Components:</b></p> <p>Shim 0.6 C Shim - 0.6 Shim 0.4 C Shim - 0.4 Shim 0.2 C Shim - 0.2</p>	<p>2 2 3 3 5 5</p>



# Duo Print Head Assembly



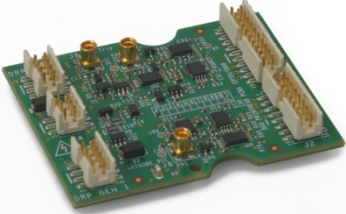

Image	Description	Quantity per kit
	<p><b>Print Head &amp; Conduit Assembly Duo Type 5 Spare</b></p> <p>3M 60 µm - <b>EPT033201SP</b>                      6M 60 µm - <b>EPT033203SP</b>                      3M 75 µm - <b>EPT033202SP</b>                      6M 75 µm - <b>EPT033204SP</b></p>	<p>I I I I</p>
	<p><b>Conduit Assembly Duo Type 5 Spare</b></p> <p>3M - <b>EPT019321SP</b>                      6M - <b>EPT033200SP</b></p>	<p>I I</p>
	<p><b>EPT017898SP</b>                      Print Head PCBA Duo Type 5 Spare</p>	<p>I</p>
	<p><b>EPT027338SP</b>                      Print Head Chassis Duo Type 5 Spare</p>	<p>I</p>

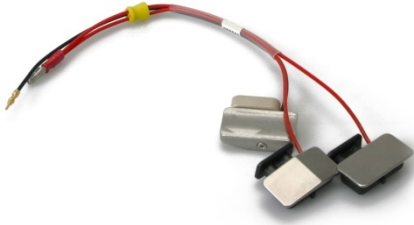




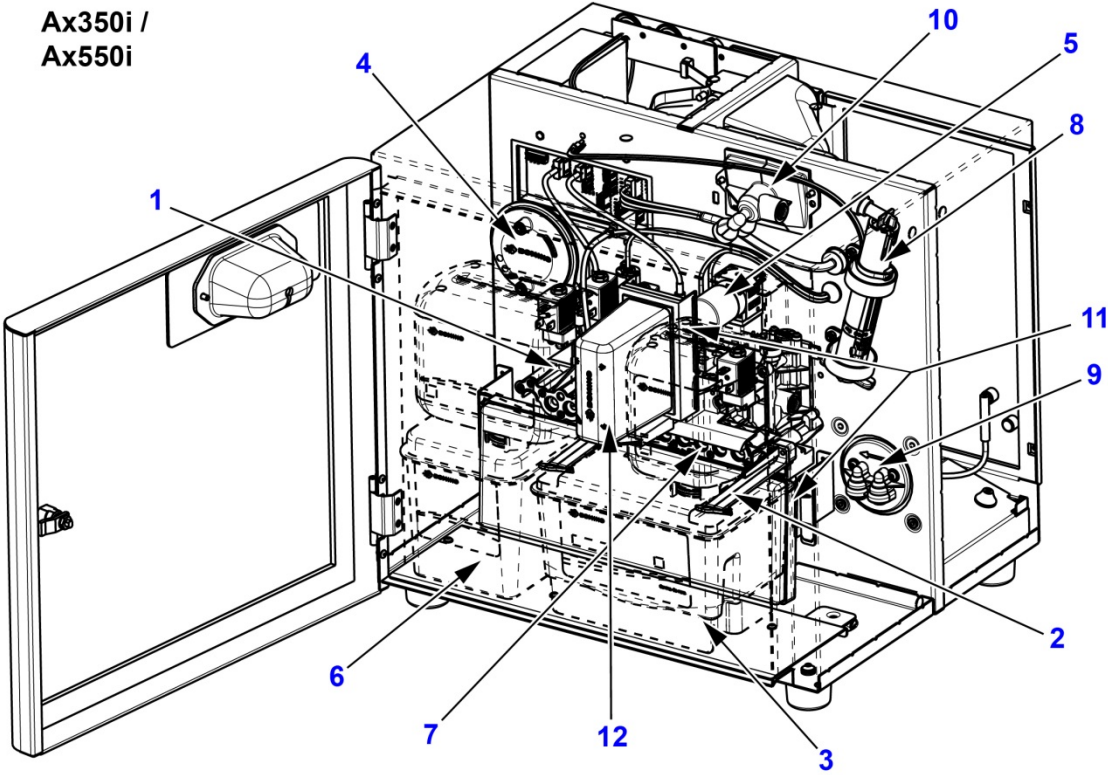
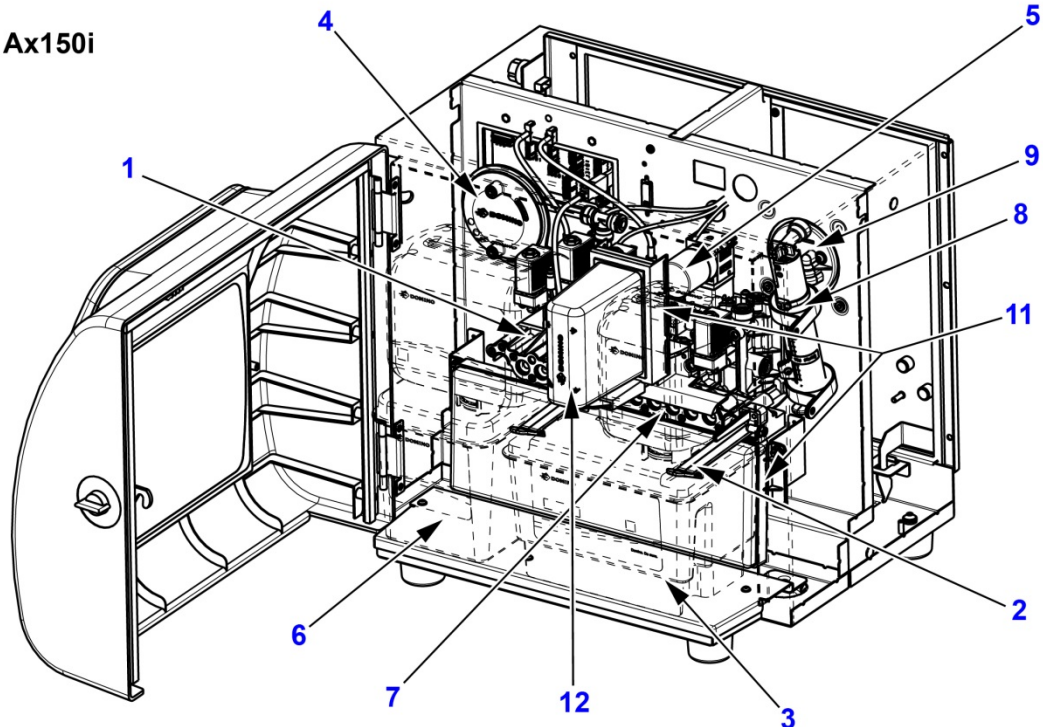




Image	Description	Quantity per kit
	<p><b>EPT027590SP</b> Deflector Plate Assembly Duo Type 5 Spare</p>	<p>1</p>
	<p><b>Drop Generator Assembly Duo Type 5 Spare</b></p> <p>LH 60 µm - <b>EPT014191SP</b> LH 75 µm - <b>EPT014699SP</b> RH 60 µm - <b>EPT014195SP</b> RH 75 µm - <b>EPT014734SP</b></p>	<p>1 1 1 1</p>
	<p><b>Strobe &amp; Charge Electrode Assembly Duo Type 5 Spare</b></p> <p>LH - <b>EPT019616SP</b> RH - <b>EPT017918SP</b></p>	<p>1 1</p>
	<p><b>EPT036557SP</b> Duo Print Head Cover Kit Type 5 Spare</p>	<p>1</p>

Image	Description	Quantity per kit
	<p><b>EPT040493SP</b>                      Duo Flush Kit Adaptor Type 5                      Spare</p>	<p>1</p>

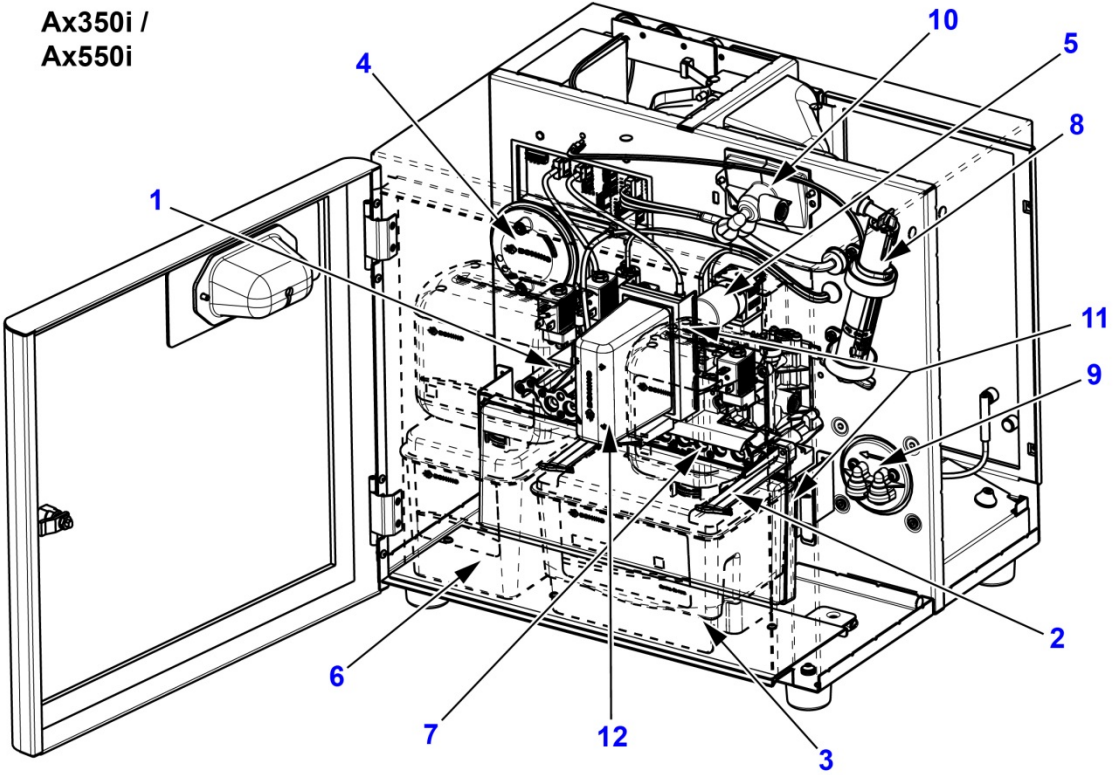
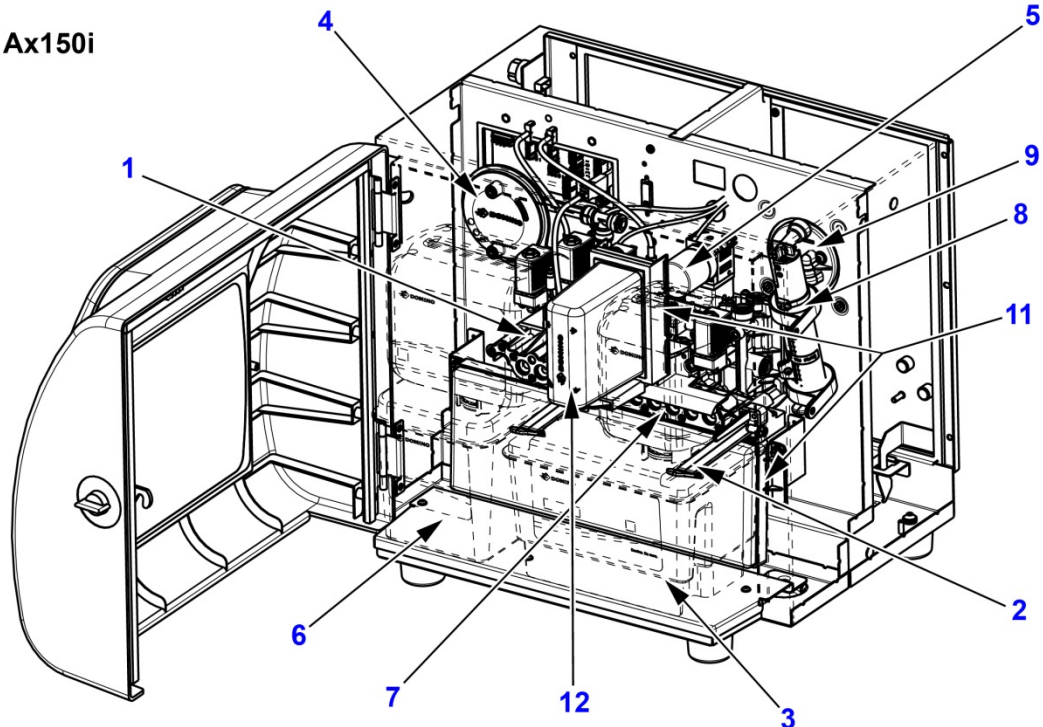


*Note: Item 10 Not Shown On Ax150i*





# i-Techx System

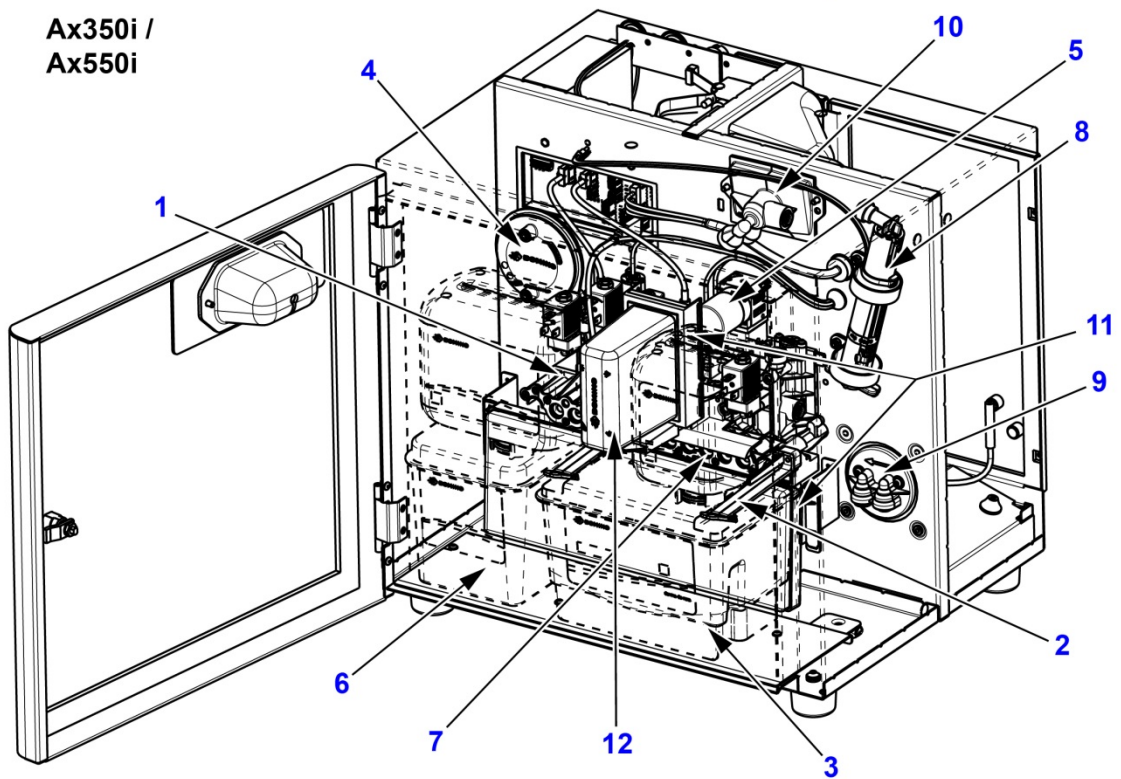
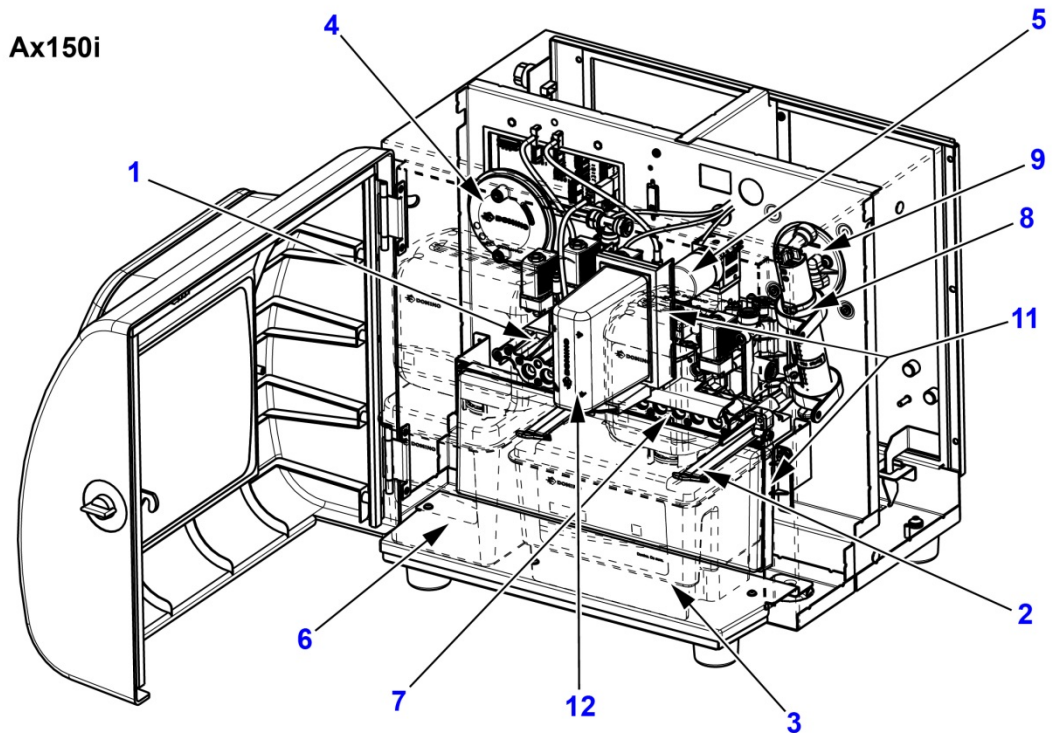
Image	Description & Location	Quantity per kit
	<p><b>(1) EPT017902SP</b> Distribution Block Assembly Type 5 Spare</p>	1
	<p><b>(2) EPT013403SP</b> Module Latch (x2) Kit Type 5 Spare</p>	2
	<p><b>(3) ITM02</b> Ax-Series ITM Type 2 (Designed for Normal Ink System)</p> <p><b>ITM03</b> Ax-Series ITM Type 3 (Designed for Heavy Duty Ink System)</p> <p><b>ITM06</b> Ax-Series ITM Type 6 (Designed for Dye-Based Ink System)</p>	1 1 1
	<p><b>(4) EPT018872SP</b> Damper Assembly Type 5 Spare</p>	1





Note: Item 10 Not Shown On Ax150i

Image	Description & Location	Quantity per kit
	<p><b>(5) EPT007517SP</b> Gutter Pump Type 5 Spare</p>	<p>I</p>
	<p><b>(6) EPT009810SP</b> Make-Up Module Type 5 Spare</p>	<p>I</p>
	<p><b>(7) EPT016786SP</b> Make-Up Module Seal Plate Type 5 Spare</p>	<p>I</p>
	<p><b>(8) EPT013507SP</b> Viscometer Assembly Kit Type 5 Spare</p> <p><b>Kit Components:</b> Viscometer Assembly Basic General Build (Bayonet) LLDPE Tubing 6mm Natural</p> <p><b>Note:</b> Tubing available separately.</p>	<p>I <b>0.4M</b></p>



*Note: Item 10 Not Shown On Ax150i*







Image	Description	Quantity per kit
	<p><b>(9) EPT023712SP</b> Gear Pump Assembly Type 5 Spare</p> <p><b>Kit Components:</b> Gear Pump LLDPE Tubing 6mm Natural LLDPE Tubing 8mm Natural</p> <p><b>Note:</b> Tubing available separately.</p>	<p>I <b>0.435M</b> <b>0.415M</b></p>
	<p><b>(10) EPT011411SP</b> Peltier Assembly Type 5 Spare</p> <p><b>Ax350i &amp; Ax550i Only</b></p> <p><b>Kit Components:</b> Peltier Assembly LLDPE Tubing 6mm Natural</p> <p><b>Note:</b> Tubing available separately.</p>	<p>I <b>0.91M</b></p>
	<p><b>(11) EPT013423SP</b> LSM Assembly Type 5 Spare</p>	<p>I</p>
	<p><b>(12) EPT013186SP</b> Quality Management Module Assembly Type 5</p>	<p>I</p>

Image	Description & Location	Quantity per kit
	<p><b>EPT012462SP</b> Quality Management Module (QMM) (Made Up Of EPT013186 &amp; EPT013423)</p>	<p>1</p>
	<p><b>EPT034279SP</b> Tube Kit Type 5 Spare</p> <p><b>Kit Components:</b> LLDPE Tubing 6mm Natural Tube 8mm x 415mm - LLDPE</p> <p><b>Note:</b> Kit components not available separately.</p>	<p><b>2M</b> <b>0.415M</b></p>
	<p><b>EPT016969SP</b> Pressure Sensor Type 5 Spare</p>	<p>1</p>
	<p><b>EPT016967SP</b> Vacuum Sensor Type 5 Spare</p>	<p>1</p>





Image	Description & Location	Quantity per kit
	<p><b>EPT018862SP</b> Feed Filter Assembly Type 5 Spare</p>	<p>1</p>
	<p><b>EPT021504SP</b> Low Drip Valve Type 5 Spare</p>	<p>1</p>
	<p><b>EPT023718SP</b> Solenoid Assembly Ink Block Type 5 Spare</p>	<p>1</p>
	<p><b>EPT014014SP</b> Temperature Sensor Type 5 Spare</p>	<p>1</p>





Image	Description & Location	Quantity per kit
	<p><b>EPT021516SP</b> Jet Pump Kit Type 5 Spare</p> <p><b>Kit Components:</b> Jet Pump Nozzle Vertical Shield O-Ring 12.45 x 1.78 EPDM O-Ring 6.5 x 1.5 EPDM</p> <p><b>Note:</b> Kit components not available separately.</p>	<p>1</p>
	<p><b>EAS000789SP</b> Make-Up Module Filter Ink System (i-Tech/Ax)</p>	<p>1</p>
	<p><b>EPT015798SP</b> Heavy Duty Gear Pump Assembly Type 5 Spare</p> <p><b>Note:</b> May vary depending on model and ink type, please contact Domino.</p>	<p>1</p>
	<p><b>Vanity Shield Spare</b></p> <p><b>EPT018246SP</b> - Ax150i</p> <p><b>EPT011688SP</b> - Ax350i &amp; Ax550i</p>	<p>1</p> <p>1</p>

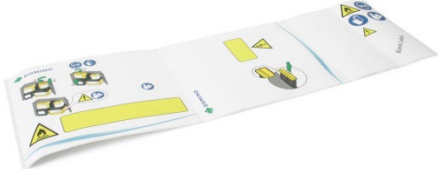



Image	Description & Location	Quantity per kit
	<p><b>EPT024197SP</b>                      Print on Demand Label                      Ax-Series Spare</p> <p><b>Note:</b> Please order this part via Oracle only - NOT BuyDomino. Information required below <b>MUST BE ADDED</b> as an attachment to the order line to produce the correct label -</p> <ul style="list-style-type: none"> <li>- Machine type.</li> <li>- Machine serial number.</li> <li>- Ink type.</li> <li>- Language</li> </ul> <p>Failure to provide this information will delay your order.</p>	<p>1</p>
	<p><b>EPT026037SP</b>                      Filter For Flush Manifold Assembly Type 5 Spare</p>	<p>1</p>
	<p><b>EPT034806SP</b>                      NK System NRV Assembly Type 5 Spare</p>	<p>1</p>
	<p><b>EPT039590SP</b>                      Seal Kit Ax Sample Maker Spare</p> <p><b>Note:</b> Used on Ax Sample Maker EPT032103</p>	<p>1</p>



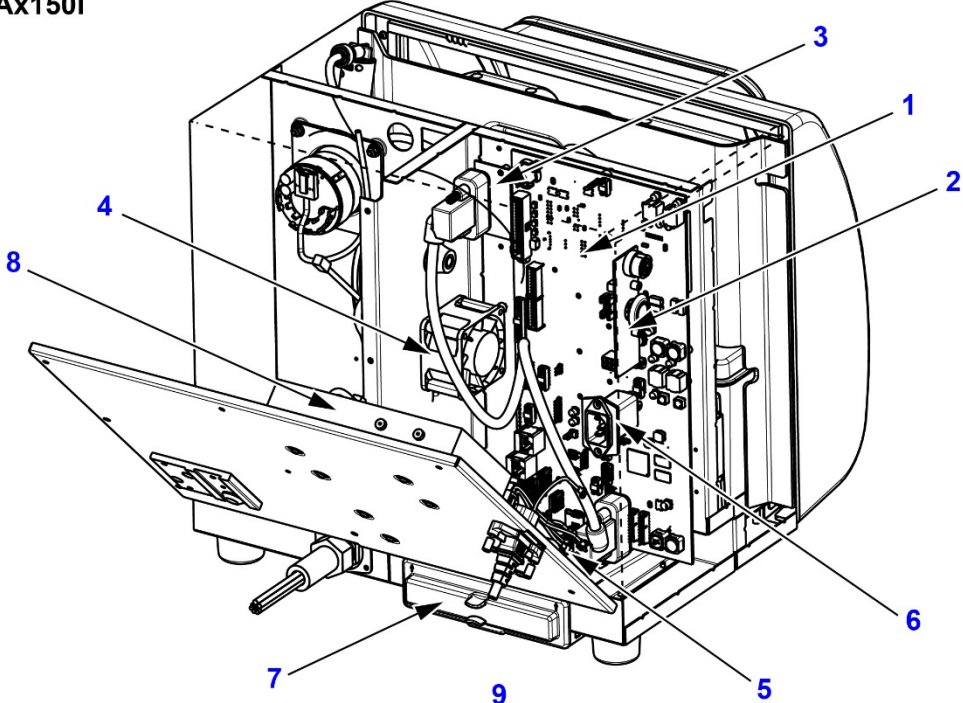
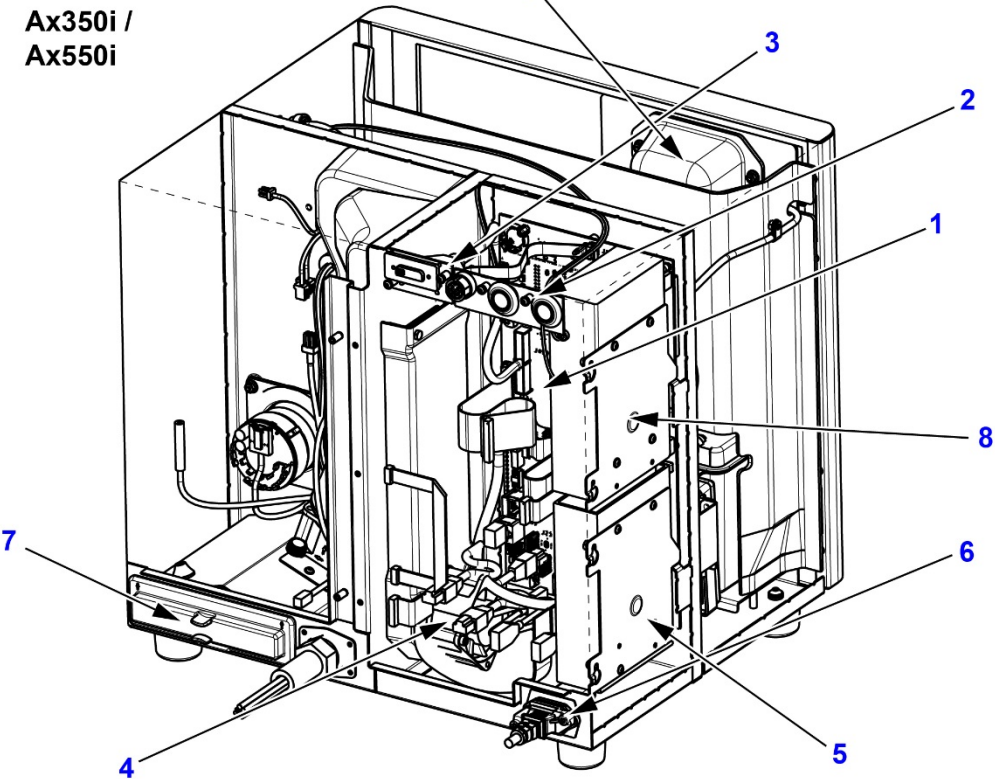
Image	Description & Location	Quantity per kit
	<p><b>EPT022060SP</b> Cabinet Fasteners Kit Type 5 Spare</p> <p><b>Kit Components:</b></p> <p>Screw M3 x 10 BUT FLG Torx T10 SS K30 PLAS-TECH <b>60</b></p> <p>Screw M4 x 10 HEX HD SS Captive Washer <b>40</b></p> <p>Washer M4 Shake Proof St St <b>20</b></p> <p>Screw M5 x 8 CSK HD Torx T25 SS <b>30</b></p> <p>Screw M5 x 30 CAP HD Torx T25 SS <b>30</b></p> <p>Screw M4 x 20 HEX HD SS Captive Washer <b>40</b></p> <p>Screw M3 x 8 CSK HD Torx T10 SS <b>20</b></p> <p>Screw M3 x 8 BUT HD Torx T10 SS IP65 Nylon Washer <b>40</b></p> <p>Screw M3 x 8 BUT HD Torx T10 SS Captive Washer <b>100</b></p> <p>Screw M4 x 45 BUT HD Torx T20 SS Captive Washer <b>20</b></p> <p>Screw M3 x 5 BUT HD Torx T10 SS Captive Washer <b>40</b></p> <p><b>Note:</b> Cabinet Fastener Kit components not available separately.</p>	

Image	Description & Location	Quantity per kit
	<p><b>EPT021551SP</b> Ink System O-Ring Kit Type 5 Spare</p> <p><b>Kit Components:</b>                      O-Ring 8.73 x 1.78 EPDM                      O-Ring 9.0 x 2.0 EDPM                      Reservoir O-Ring                      O-Ring 11.0 x 2.0 EDPM                      O-Ring 12.42 x 1.78 EPDM                      ORING 2.9X1.78 EPDM                      ORING 4_48X1_78 EPDM                      ORING 5.28X1.78 EPDM                      ORING 6.5X1.5 EPDM</p> <p><b>Note:</b> Ink System O-Ring Kit components not available separately.</p>	<p><b>20</b> <b>20</b> <b>10</b> <b>10</b> <b>20</b> <b>10</b> <b>40</b> <b>10</b> <b>10</b></p>
	<p><b>EPT021552SP</b> Ink System Fasteners Kit Type 5 Spare</p> <p><b>Kit Components:</b>                      Screw 3 x 24.5 WNI56-2 T10 A2 Remform                      Screw K40 x 14 WNI45I                      Screw 3 x 10 WNI56-2 T10 A2 Remform                      Screw 3 x 8 WNI56-1 T10 A2 Remform                      Screw 3 x 18 WNI56-2 T10 A2 Remform</p> <p><b>Note:</b> Ink System Fastener Kit components not available separately.</p>	<p><b>100</b> <b>60</b> <b>200</b> <b>100</b> <b>50</b></p>

Ax150i




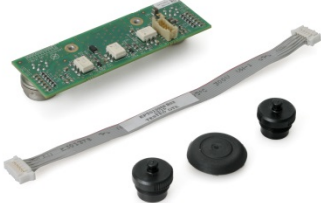


Ax350i /  
Ax550i



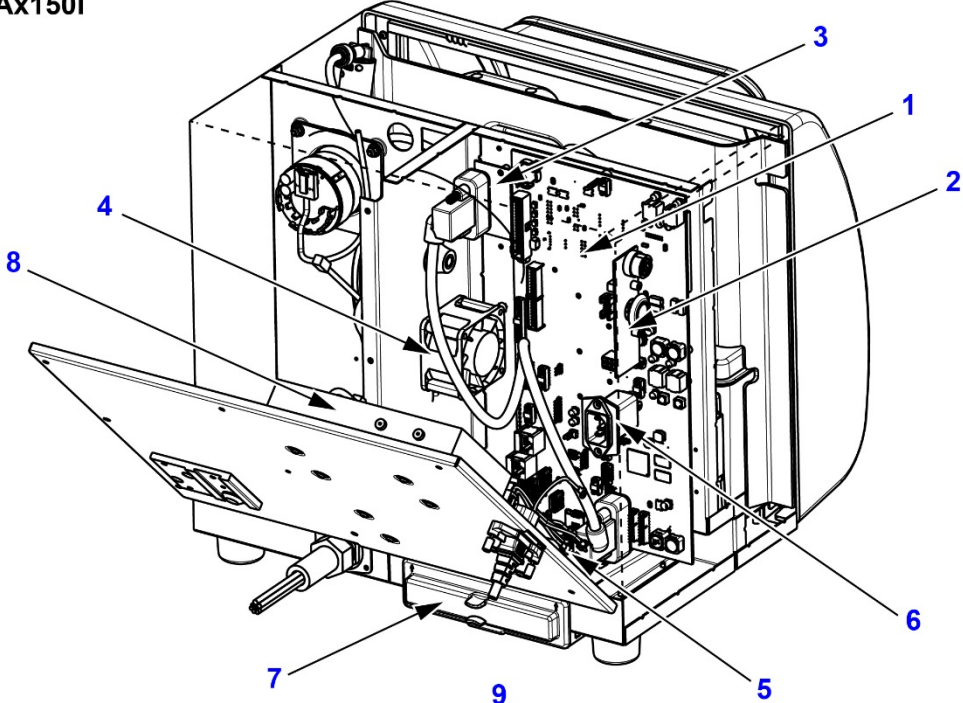
Note: Item 9 Not Shown On Ax150i



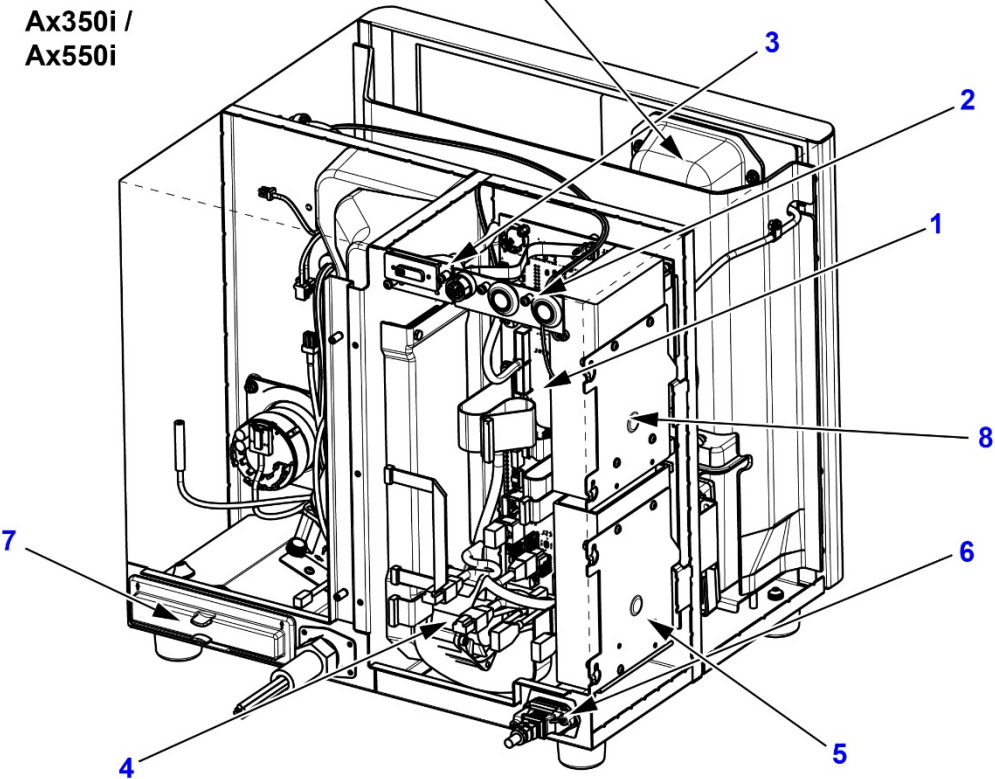
# Electronics Cabinet

Image	Description & Location	Quantity per kit
	<p><b>(1) EPT017909SP</b> Main Control PCB Type 5 Spare</p>	<p>1</p>
	<p><b>(2) EPT013308SP</b> Product Detect / Shaft Encoder PCB Kit Type 5 Spare</p> <p><b>Kit Components:</b> Product Detect / Shaft Encoder PCBA - Dual Cap, Protection, Female Socket Cable, Product Detect / Shaft Encoder</p> <p><b>Note:</b> Kit components not available separately.</p>	<p>1 2 1</p>
	<p><b>(3) External User Interface PCB Kit Type 5 Spare</b></p> <p><b>EPT047162SP</b> - Ax150i <b>EPT012907SP</b> - Ax350i/Ax550i</p> <p><b>Kit Components:</b> User Interface PCBA Cable, UI</p> <p><b>Note:</b> Kit components not available separately.</p>	<p>1 1</p>
	<p><b>(4) EPT017291SP</b> Fan Type 5 Spare</p>	<p>1</p>

Ax150i



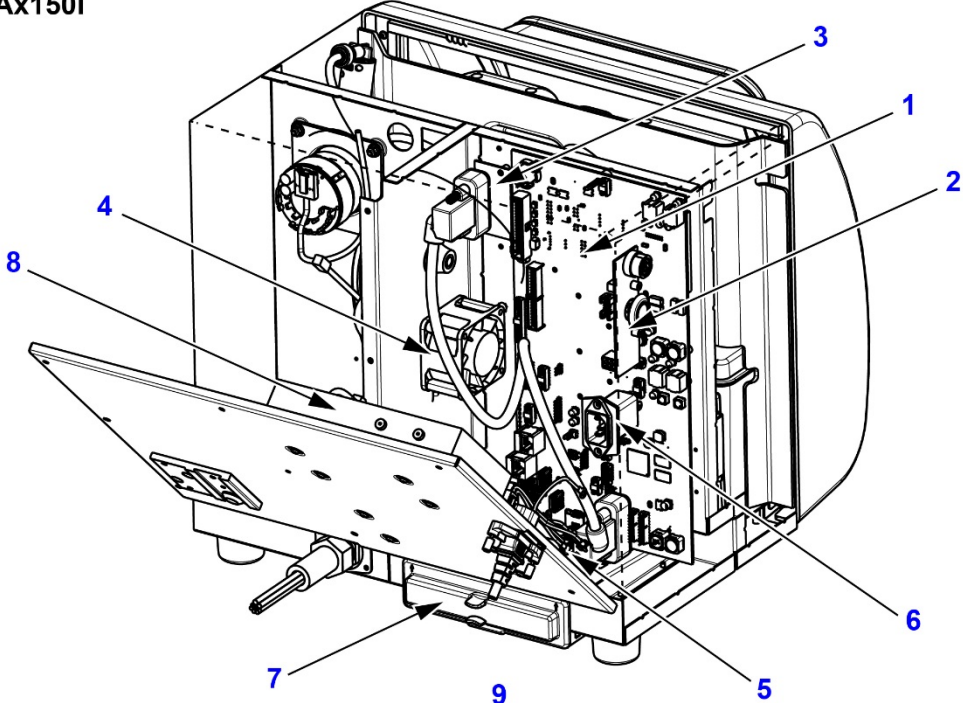
Ax350i / Ax550i



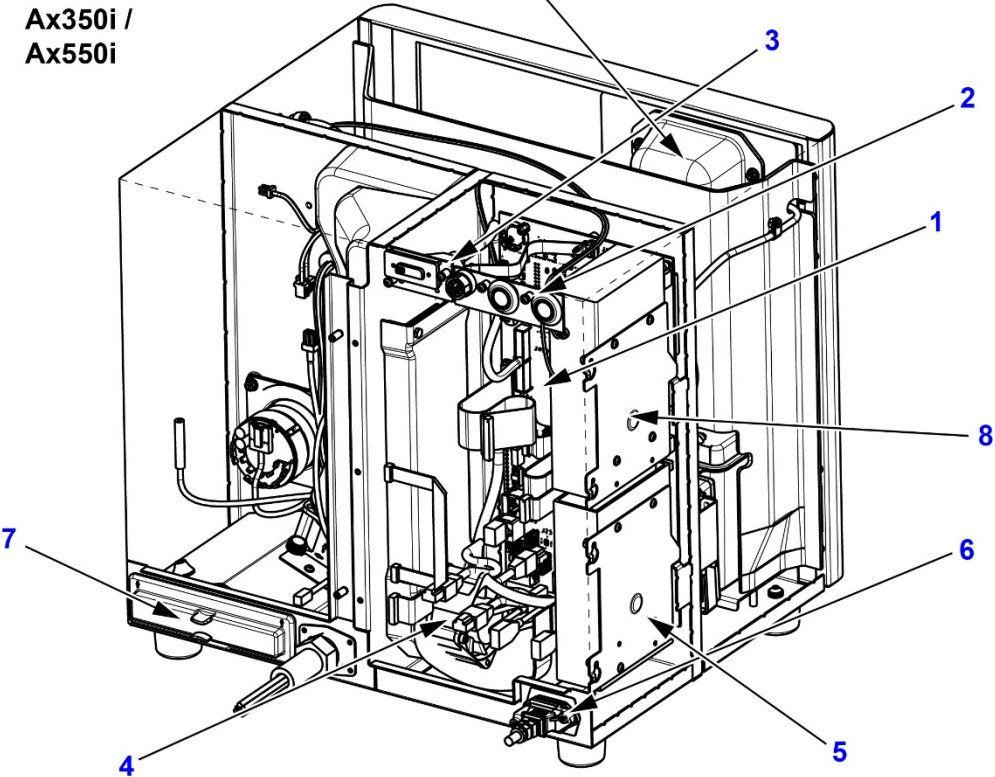
Note: Item 9 Not Shown On Ax150i

Image	Description & Location	Quantity per kit
	<p><b>(5) EPT033207SP</b> LVPS 2 Ultrawide &amp; 6A Power Connector Kit Spare</p>	<p>1</p>
	<p><b>(6) EPT026355SP</b> Power Connector Type 6 Spare</p>	<p>1</p>
	<p><b>EPT015415SP</b> Filter Assembly Type 5 Spare</p>	<p>1</p>
	<p><b>(7) EPT016386SP</b> Filter Handle Type 5 Spare</p>	<p>1</p>
	<p><b>(8) EPT006886SP</b> High Voltage PSU Type 5 Spare</p>	<p>1</p>

Ax150i



Ax350i / Ax550i



Note: Item 9 Not Shown On Ax150i

Image	Description	Quantity per kit
	<p><b>(9) EPT014385SP</b> Keypad Membrane, 4 Button (Ax350i/550i) Spare</p> <p><b>Ax350i &amp; Ax550i Only</b></p> <p><b>Kit Components:</b> Keypad Membrane, 4 Button Cable, Keypad Cover, Keypad</p> <p><b>Note:</b> Kit components not available separately.</p>	<p style="text-align: center;">     </p>
	<p><b>EPT028743SP</b> Front Door UI Parts Kit (Ax150i) Spare</p> <p><b>Kit Components:</b> Screw M3 x 10 BUT FLG Torx T10 SS K30 PLAS-TECH PCBA 7" UI HEX Stand Off Cable, UI Cable, Keypad 7" UI Front Assembly</p> <p><b>Note:</b> Kit components not available separately.</p>	<p style="text-align: center;">12    2      </p>
	<p><b>EPT013856SP</b> Cable, UI Spare</p>	<p style="text-align: center;"> </p>
	<p><b>EPT013987SP</b> Cable, Keypad Spare</p>	<p style="text-align: center;"> </p>



Image	Description	Quantity per kit
	<p><b>EPT019062SP</b> 7" UI Front Assembly Spare</p>	<p>1</p>
	<p><b>EPT019071SP</b> PCBA 7" UI Spare</p>	<p>1</p>
	<p><b>EPT029088SP</b> Front Door Assembly (No UI) Parts Kit (AxI 50i) Spare</p>	<p>1</p>
	<p><b>EPT019979SP</b> 32KB Smart Card Type 5 Spare</p>	<p>1</p>



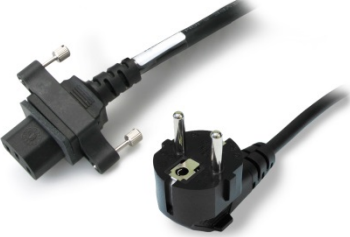




Image	Description	Quantity per kit
	<p><b>EPT015153SP</b> Solenoid Valve Harness, Type 5 Spare</p>	<p>1</p>
	<p><b>EPT014018SP</b> Mains Lead (UK) Type 5 Spare</p>	<p>1</p>
	<p><b>EPT020200SP</b> Mains Lead (Europe) Type 5 Spare</p>	<p>1</p>
	<p><b>EPT020198SP</b> Mains Lead (USA) Type 5 Spare</p>	<p>1</p>

Image	Description	Quantity per kit
	<p><b>EPT020197SP</b> Mains Lead (China) Type 5 Spare</p>	<p>1</p>
	<p><b>EPT020202SP</b> Mains Lead (India) Type 5 Spare</p>	<p>1</p>
	<p><b>EPT029254SP</b> Mains Lead (Taiwan) Type 5 Spare</p>	<p>1</p>
	<p><b>EPT032070SP</b> Mains Lead (Argentina) Type 5 Spare</p>	<p>1</p>



Image	Description	Quantity per kit
	<p><b>EPT020193SP</b> Mains Lead (No Plug) Type 5 Spare</p>	<p>1</p>
	<p><b>EPT022059SP</b> Blanking Plugs &amp; Caps Kit Type Spare</p> <p><b>Kit Components:</b> Blanking Plug, Large Blanking Plug, Medium Blanking Plug, Small Cap, Protection, Male Socket Cap, Protection, Female Socket Grommet 17mm Blind</p> <p><b>Note:</b> Kit components not available separately.</p>	<p>1 1 1 1 1 1</p>
	<p><b>EPT019977SP</b> Programmed 8GB Flash Card Type 5 Spare</p>	<p>1</p>
	<p><b>EPT032093SP</b> Encoder Cable, Inline Signal Conditioner Spare</p>	<p>1</p>

Image	Description	Quantity per kit
	<p><b>EPT035140SP</b> Extended Print Head Bracket and Holster Kit For Moba Egg Graders (Ax-Series) Spare</p> <p><b>Kit Components:</b> Print Head Mounting Plate (Long) Kit A-Series Holster, Standard - No Slots</p> <p><b>Note:</b> Kit components not available separately.</p>	<p>1</p> <p>1</p>
	<p><b>EPT041081SP</b> DCI Port Kit</p>	<p>1</p>
	<p><b>01210</b> Fuse 20x5 (T) 1A (240V)</p>	<p>1</p>

# AirDryer Spares






Image	Description	Quantity per kit
	<b>EPP004073SP</b> Air Shut Off Solenoid Valve MK3	1
	<b>EPP004074SP</b> Flow Control Valve MK3	1
	<b>EPP004075SP</b> Pressure Switch MK3	1
	<b>EPP004076SP</b> Filter Regulator with Constant Bleed Drain MK3	1

Image	Description	Quantity per kit
	<p><b>EPP004077SP</b> Filter Media MK3</p>	<p>1</p>
	<p><b>EPP004162SP</b> 6mm Bulkhead Connector &amp; 6mm - 4mm Reducer Kit Spare</p>	<p>1</p>

# Documentation

Image	Description	Quantity per kit
	<p><b>Ax-Series (Ax150i, Ax350i, Ax550i) User Documentation Pack</b></p> <p>English - <b>EPT029891</b>            Albanian - <b>EPT031840</b>            Arabic - <b>EPT031841</b>            Bulgarian - <b>EPT031842</b>            Chinese (Simplified) - <b>EPT031843</b>            Chinese (Traditional) - <b>EPT031844</b>            Croatian - <b>EPT031845</b>            Czech - <b>EPT031846</b>            Danish - <b>EPT031847</b>            Dutch - <b>EPT031848</b>            Estonian - <b>EPT031849</b>            Farsi - <b>EPT031851</b>            Finnish - <b>EPT031852</b>            French - <b>EPT031833</b>            German - <b>EPT031832</b>            Greek - <b>EPT031853</b>            Hebrew - <b>EPT031854</b>            Hungarian - <b>EPT031855</b>            Italian - <b>EPT031856</b>            Japanese - <b>EPT031857</b>            Korean - <b>EPT031858</b>            Latvian - <b>EPT031859</b>            Lithuanian - <b>EPT031860</b>            Macedonian - <b>EPT031861</b>            Norwegian - <b>EPT031873</b>            Polish - <b>EPT031862</b>            Portuguese - <b>EPT031839</b>            Romanian - <b>EPT031863</b>            Russian - <b>EPT031864</b>            Serbian - <b>EPT031865</b>            Slovak - <b>EPT031866</b>            Slovene - <b>EPT031867</b>            Spanish - <b>EPT031868</b>            Swedish - <b>EPT031869</b>            Thai - <b>EPT031870</b>            Turkish - <b>EPT031871</b>            Vietnamese - <b>EPT031872</b></p>	<p>1</p>

Image	Description	Quantity per kit
	<b>EPT031177</b> Ax-Series Pharma Validation Pack	1

# Notes



## Domino Ax-Series Spare Catalogue - Part No. EPT023746

Domino Printing Sciences plc has a policy of continuous product improvement, the Company therefore reserves the right to modify the specification contained within this document without notice.

© Domino Printing Sciences plc 2020. All rights reserved.

[www.domino-printing.com](http://www.domino-printing.com)

**Domino Printing Sciences plc**  
Bar Hill  
Cambridge CB23 8TU  
England  
Tel: +44 (0)1954 782551  
Fax: +44 (0)1954 782874  
Email: [enquiries@domino-uk.com](mailto:enquiries@domino-uk.com)